



Expertise Applied | Answers Delivered

Data Center Solutions

Application Guide

Selecting the right products to empower sustainable data centers.



Design with Confidence

Supported by our deep application expertise and extensive portfolio

About This guide

This guide provides an overview of the Littelfuse technologies used in various data center and cloud applications. It is designed to help you quickly find design solutions appropriate for your application.

Topic	Page
Littelfuse: Everywhere, Every Day	3
Product and Application Matrix	6-9
Applications	10-13
Highlighted Products	14
Additional Resources	15
Global Lab Capabilities	16

Specifications, descriptions, and illustrative material in this Guide are as accurate as known at the time of publication, but are subject to changes without notice. Visit [Littelfuse.com](https://www.littelfuse.com) for more information.

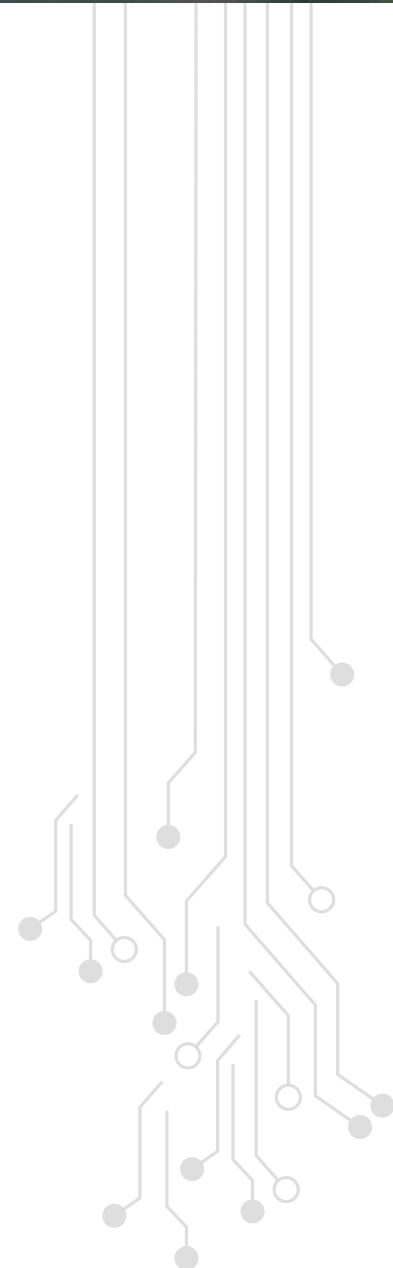



Littelfuse: Everywhere, Every Day

Founded in 1927, Littelfuse is a diversified industrial technology manufacturing company empowering a sustainable, connected, and safer world. Across more than 20 countries, and with about 18,000 global associates, we partner with customers to design and deliver innovative, reliable solutions.

Littelfuse offers an extensive technology portfolio: fuses, semiconductors, polymers, ceramics, relays, sensors, switches, and more. Serving over 100,000 end customers, our products are found in a variety of industrial, transportation, and electronics end markets—everywhere, every day.

Why Choose Littelfuse?

Complementing our wide portfolio of circuit protection products is a global network of design and technical support expertise. We offer decades of design experience to help you address application challenges and achieve regulatory compliance.

Your Single Source

Littelfuse offers an extensive circuit protection product line. We design forward-thinking, application-specific solutions to provide assurance that your most demanding requirements will be met. Our goal is to provide the most complete range of options so that you will not have to compromise.

Testing Support

Littelfuse can help ensure that your products will withstand most common threats repeatedly and will fail safely under extreme circumstances. We can serve as an independent source to provide assistance as you design by offering lab testing capabilities. With more than 15 locations worldwide, Littelfuse labs are equipped to provide testing that includes overcurrent, overvoltage, Electrostatic Discharge (ESD), temperature, failure analysis, material analysis, and application performance.

Application Knowledge

For almost 100 years, Littelfuse has maintained a focus on circuit protection, and we will continue to adapt as technologies evolve. Engineers and circuit designers around the world have come to rely on our products and application knowledge to support their designs.

Global Support

Littelfuse stays close to our customers. We have manufacturing, lab, and design facilities located around the globe, so application knowledge and technical support are always locally available. We also offer a network of regional customer support offices and hundreds of independent authorized distributor contacts to assist you. Visit Littelfuse.com/contact-us to find local support near you.

Standards Compliance Expertise

Most Littelfuse products comply with a wide range of applicable industry and government guidelines as well as our own rigorous quality and reliability criteria. We continually look forward and adapt to changing requirements so that our products will comply with industry-specific national and international standards and regulations, such as CCC (China Compulsory Certificate), CSA (Canadian Standards Association), IEC (International Electrotechnical Commission), IEEE (Institute of Electrical and Electronics Engineers), ISO (International Organization for Standardization), ITU (International Telecommunication Union), METI (Ministry of Economy, Trade and Industry), RoHS (Reduction of Hazardous Substances), Telcordia, TIA (Telecommunications Industry Association), and many more.

Operational Excellence

With our global manufacturing footprint, Littelfuse is firmly committed to manufacturing quality products at a competitive price. We build quality into our products and services, striving for zero defects in everything we do to reduce costs and exceed our customers' expectations every day.

Quality Assurance

Our global manufacturing facilities abide by strict quality assurance requirements and hold the following quality management system registrations:

- ISO 9001,
- ISO 14001, and
- IATF 16949.

Empowering a Sustainable Data Center

Today's data centers must handle the rapid rise in data volume from millions of devices that make up the Internet of Things (IoT), 5G and 6G, and High Performance Computing (HPC), which is used to develop many artificial intelligence applications.

With increasing data traffic, power demand is escalating, driven by increased thermal design of CPUs and GPUs. We help you empower a sustainable and reliable data center.

Power Distribution and Controls



HVAC System



MV/LV Switchgear/
Switchboard
Power Distribution



Automatic
Transfer
Switch (ATS)

Server/Storage/ Networking Equipment/ Redundant Power Supplies/Switch



Rack
Server

Communication Equipment and Routers

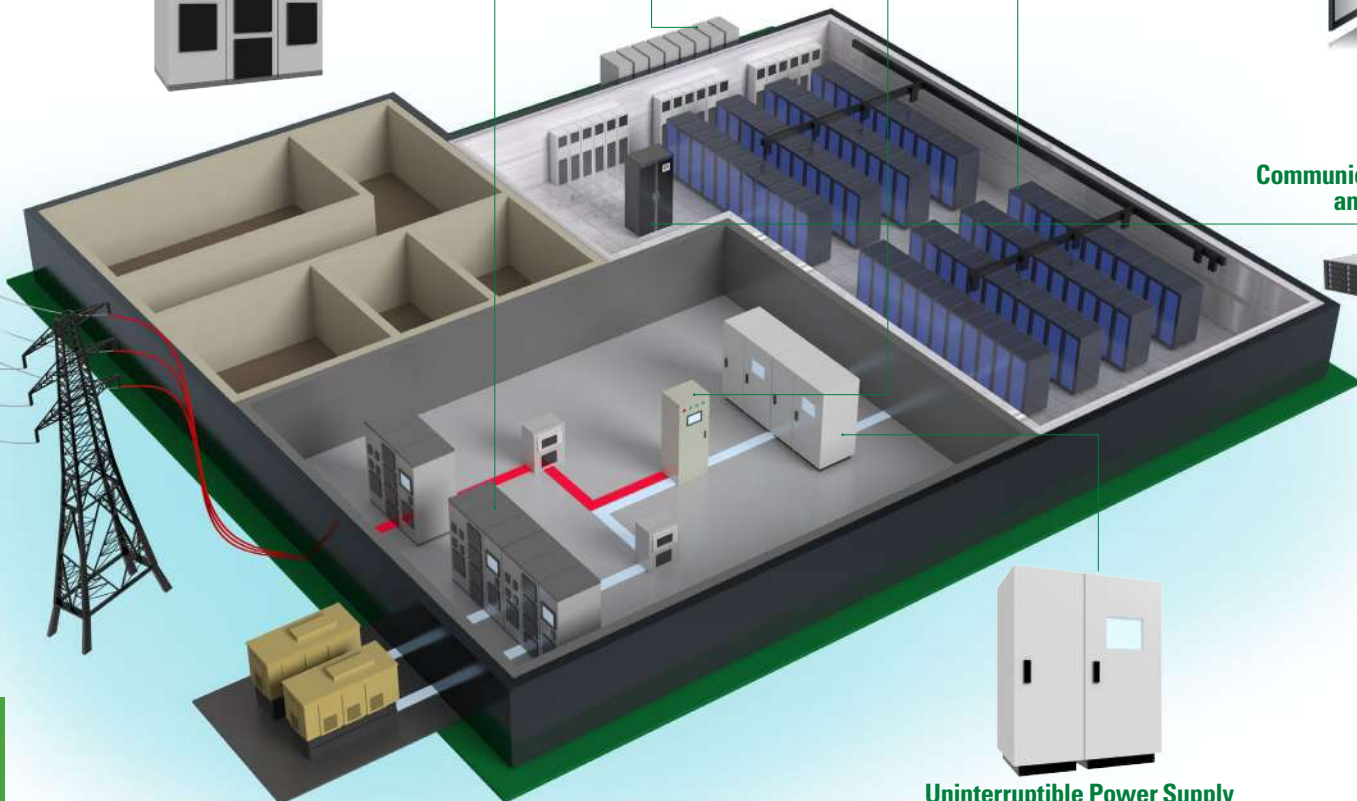

Uninterruptible Power Supply

- High-power battery systems
- Power Factor Correction (PFC) in high wattage power supplies
- Power Distribution Units (PDUs)

*The devices illustrated here address only a few of the data center areas for which Littelfuse can deliver industry-leading solutions. For a more complete view of Littelfuse solutions by application, consult the selection matrix included in this document.

Empowering a Safer World

Types of Faults	Possible Effects of Unprotected Faults	Protection Solutions
Electrostatic Discharge (ESD)	Faulty circuit operation, latent defects, and even catastrophic failure of sensitive data center equipment.	Polymer ESD, Multilayer Varistors, TVS Diode Arrays
Load-switching transients in power electronic circuits	Equipment failure or faulty operation, leading to downtime or corrupt data	Metal Oxide Varistors, Gas Discharge Tubes, TVS Diodes
Induced surges (lightning)	Equipment failure, leading to downtime	Metal Oxide Varistors, Gas Discharge Tubes, Protection Thyristors, TVS Diodes, Surge Protective Devices (SPD2)
Overload/short circuit current	Excessive current can result in complete circuit destruction and possible fire, electrocution, or explosion. Short circuits can cause arcs, shock, and fire hazards.	Fuses, Resettable PTCs
Ground fault	Premature equipment failure and possible arc flash	NGR, NGR Monitor, Ground-Fault Relay

How Is the Surface Mount Fuse Used Here?

881 Series–Nano²® High Current Subminiature Surface Mount Fuse

Provides a single-fuse solution for high current application requirements. The convenience of parallel fusing eliminates the need for industrial-type fuses.

Ideal for overcurrent protection for high operating current 60 A to 100 A applications in a limited space, such as high density servers.

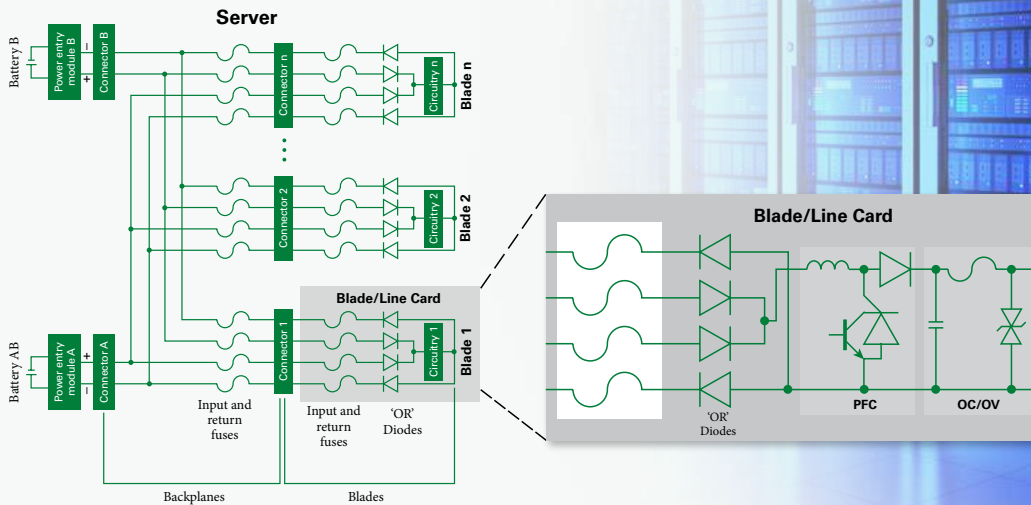
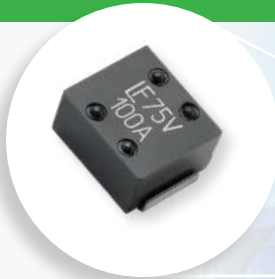

Circuit Protection

Product and Application Matrix

Littelfuse Product Series	Computer and Networking Equipment						Uninterruptible Power Supply			Communication Equipment				Power Distribution and Controls						
	USB	Ethernet	RS-232/RS-485	eSATA/SATA	Power Supply	Fans	AC Power Supply	Converter and Inverter	Battery Bank	Modem	ADSL Splitters, Channel/Data Service Unit	Repeaters, Mux, WAN	VoIP, LAN	Switchgear Panel	Automatic Transfer Switch	Power Distribution Unit	Busway	Panelboard	Backup Generator	HVAC
Resettable PPTCs																				
Low Resistance	-	-	-	-	-	-	-	-	•	-	-	-	-	-	-	-	-	-	-	-
Surface Mount	•	•	-	-	•	•	-	•	•	•	•	•	-	-	-	-	-	-	-	•
Radial Leaded	-	-	-	-	•	•	•	•	-	•	•	•	-	-	-	-	-	-	-	•
Telecom	-	•	•	-	-	-	-	-	-	•	•	•	-	-	-	-	-	-	-	-
Fuses																				
Surface Mount	-	•	-	-	•	•	•	•	•	-	-	-	•	•	-	-	-	-	•	•
Cartridge	-	-	-	-	•	•	•	•	•	•	•	•	•	•	•	•	•	•	•	•
Holders, Blocks, and Clips	-	-	-	-	•	•	•	-	•	-	-	-	•	•	•	•	•	•	•	•
Semiconductor	-	-	-	-	-	-	-	•	-	-	-	-	-	-	-	-	-	-	-	-
Industrial Power and UL Class Fuses	-	-	-	-	-	-	•	•	•	-	-	-	•	•	•	•	•	•	•	•
Medium Voltage (E-Rated, R-Rated)	-	-	-	-	-	-	-	-	-	-	-	-	-	-	-	-	-	-	•	-
Protection IC																				
eFuse	•	-	-	-	-	-	-	-	-	-	-	-	-	-	-	-	-	-	-	-
Polymer ESD (PESD) Suppressors																				
PESD Discrete and Array	•	•	•	•	-	-	-	-	-	•	•	•	•	-	-	-	-	-	-	-
XTREME-GUARD™	•	•	•	•	-	-	-	-	-	•	•	•	•	-	-	-	-	-	-	-
TVS Diodes																				
Surface Mount	•	•	•	•	•	•	•	•	•	•	•	•	-	-	-	-	-	-	-	-
Leaded	•	•	-	•	•	•	•	•	•	•	•	•	•	•	•	•	•	•	•	•
High Power	-	-	-	-	•	-	-	•	-	-	-	-	-	•	•	•	•	•	-	-
TVS Diode Array																				
General Purpose	-	-	-	-	-	-	-	-	-	•	•	•	•	-	-	-	-	-	-	-
Low Capacitance	•	•	•	•	-	-	-	-	-	•	•	•	•	-	-	-	-	-	-	-
Lightning Surge	•	•	-	-	-	-	-	-	-	•	•	•	•	-	-	-	-	-	-	-
Varistors (MOV/MLV)																				
Radial Leaded	-	-	-	-	•	•	•	•	-	-	-	-	•	•	•	•	•	•	•	-
Surface Mount	-	-	-	-	•	•	•	•	•	-	-	-	-	-	-	-	-	-	-	-
Thermally Protected	-	-	-	-	•	•	•	•	-	-	-	-	•	•	•	•	•	•	•	•
Industrial High Energy	-	-	-	-	•	-	•	-	-	-	-	-	•	•	•	•	•	•	•	•
Multilayer Varistors	•	•	•	•	-	-	-	-	•	•	•	•	-	-	-	-	-	-	-	-
Gas Discharge Tube (GDT)																				
High Voltage	-	-	-	-	•	-	•	-	-	•	•	-	-	•	•	•	•	•	•	-
Squared	-	-	-	-	-	-	-	-	-	•	•	•	-	-	-	-	-	-	-	-
Medium Surge	-	•	•	-	-	-	-	-	-	•	•	•	-	-	-	-	-	-	-	-
Protection Thyristor																				
SIDActar®	-	•	•	-	-	-	-	-	-	•	•	•	-	-	-	-	-	-	-	-
Surge Protection Device																				
SPD2	-	-	-	-	-	-	•	•	•	-	-	-	•	•	•	•	•	•	•	•

Switching and Control

Product and Application Matrix

Littelfuse Product Series	Computer and Networking Equipment						Uninterruptible Power Supply			Communication Equipment					Power Distribution and Controls					
	USB	Ethernet	RS-232/RS-485	eSATA/SATA	Power Supply	Fans	AC Power Supply	Converter and Inverter	Battery Bank	Modem	ADSL Splitters, Channel/Data Service Unit	Repeaters, Mux, WAN	VoIP, LAN	Switchgear Panel	Automatic Transfer Switch	Power Distribution Unit	Busway	Panelboard	Backup Generator	HVAC
Solid State Relays																				
Normally Open and Normally Closed Relays	-	-	-	-	-	-	-	-	-	•	•	•	•	-	-	-	-	-	-	-
Power Relays	-	-	-	-	-	-	•	•	•	•	•	•	•	•	•	•	-	-	-	•
Isolated High-Voltage Analog Switches	-	-	-	-	-	-	-	-	•	•	•	•	•	•	•	-	-	-	-	-
AC Power Switches	-	-	-	-	-	-	-	-	-	-	-	-	•	•	•	-	-	-	•	•
Line Card Access Switches	-	-	-	-	-	-	-	-	-	-	-	•	-	-	-	-	-	-	-	-
Current-Limited Solid State Relays	-	-	-	-	•	-	-	-	-	•	-	-	•	•	•	-	-	-	-	-
Optocouplers																				
High-Speed Optocouplers	•	•	•	•	•	-	•	•	•	•	•	•	•	-	-	-	-	-	-	-
Linear Optocouplers	-	-	-	-	•	-	•	•	•	-	-	-	-	-	-	-	-	-	-	-
Isolation Amplifiers	-	-	-	-	•	-	•	•	•	-	-	-	-	-	-	-	-	-	-	-
Single and Dual Optocouplers	-	-	-	-	-	-	-	-	•	•	•	•	-	-	-	-	-	-	-	-
Protection Relays																				
NGR and NGR Monitor	-	-	-	-	-	-	-	-	-	-	-	-	-	•	-	•	-	-	•	-
Ground-Fault Relay	-	-	-	-	-	-	-	-	-	-	-	-	-	•	-	•	-	-	•	-
Arc-Flash Relay	-	-	-	-	-	-	-	-	-	-	-	-	-	•	•	•	•	•	•	•
(Hartland) Controls																				
Contactors (HCD)	-	-	-	-	-	-	-	-	-	-	-	-	-	-	-	-	-	-	-	•
Transformers (HCT)	-	-	-	-	-	-	-	-	-	-	-	-	-	-	-	-	-	-	-	•
Capacitors (HCK)	-	-	-	-	-	-	-	-	-	-	-	-	-	-	-	-	-	-	-	•
Mechanical Relays (HCR)	-	-	-	-	-	-	-	-	-	-	-	-	-	-	-	-	-	-	-	•
Circuit Breakers (HCB)	-	-	-	-	-	-	-	-	-	-	-	-	-	-	-	-	-	-	-	•
C&K Switches																				
Tactile	-	-	-	-	•	-	•	•	-	-	-	-	-	-	-	•	-	-	-	-
Detect	-	-	-	-	•	-	•	•	-	-	-	-	-	-	-	•	-	-	-	-
Linear DIP	-	-	-	-	•	-	•	•	-	-	-	-	-	-	-	•	-	-	-	-
Pushbutton	-	-	-	-	•	-	•	•	-	-	-	-	-	•	-	•	-	-	-	-
Rocker	-	-	-	-	-	-	-	-	-	-	-	-	-	-	-	•	-	-	-	-
Toggle	-	-	-	-	-	-	-	-	-	-	-	-	-	•	-	-	-	-	-	-
Snap	-	-	-	-	-	-	-	-	-	-	-	-	-	-	-	•	-	-	-	-
Rotary	-	-	-	-	-	-	-	-	-	-	-	-	-	•	-	•	-	•	-	-

How Is the Fuse Used Here?

TLS Series Compact Current Limiting Telecommunications Fuse

In today's data centers, the amount of power supplied by the data center rack power supply has increased, but the space allowed for the power supply remains the same.

The TLS Series fuse is ideal for overcurrent protection for rack power supplies, as it comes in a small, compact form factor that could be mounted to a circuit board.



Power Semiconductor

Product and Application Matrix

Littelfuse Product Series	Computer and Networking Equipment						Uninterruptible Power Supply			Communication Equipment				Power Distribution and Controls						
	USB	Ethernet	RS-232/RS-485	eSATA/SATA	Power Supply	Fans	AC Power Supply	Converter and Inverter	Battery Bank	Modem	ADSL Splitters, Channel/Data Service Unit	Repeaters, Mux, WAN	VoIP, LAN	Switchgear Panel	Automatic Transfer Switch	Power Distribution Unit	Busway	Panelboard	Backup Generator	HVAC
Diodes																				
Rectifier Diode	-	-	-	-	•	-	•	•	•	-	-	-	-	•	•	•	•	-	•	•
Fast Recovery Diode	-	-	-	-	•	-	•	•	•	-	-	-	-	•	•	•	•	-	•	•
Schottky Diode	-	-	-	-	•	-	•	•	•	-	-	-	-	•	•	•	•	-	•	•
Phase Control Thyristor	-	-	-	-	-	-	•	-	-	-	-	-	-	-	•	-	-	-	•	•
Thyristor/Diode Module	-	-	-	-	•	-	•	•	•	-	-	-	-	•	•	•	•	-	•	•
Rectifier Module	-	-	-	-	•	-	•	•	•	-	-	-	-	•	•	•	•	-	•	•
IGBT																				
Discrete IGBT	-	-	-	-	•	-	•	•	•	-	-	-	-	•	•	•	•	-	•	•
IGBT Module	-	-	-	-	•	-	•	•	•	-	-	-	-	•	•	•	•	-	•	•
SMPD IGBT	-	-	-	-	•	-	•	•	•	-	-	-	-	•	•	•	•	-	•	•
Power MOSFET																				
Discrete MOSFET	-	-	-	-	•	-	•	•	•	-	-	-	-	•	•	•	•	-	•	•
MOSFET Module	-	-	-	-	•	-	•	•	•	-	-	-	-	•	•	•	•	-	•	•
SMPD MOSFET	-	-	-	-	•	-	•	•	•	-	-	-	-	•	•	•	•	-	•	•
Drivers																				
MOSFET and IGBT Gate Drivers	-	-	-	-	•	-	•	•	-	-	-	-	-	-	-	-	-	-	•	•
High Voltage Gate Drivers	-	-	-	-	•	-	•	•	-	-	-	-	-	-	-	-	-	-	•	•
Optically Isolated Gate Drivers	-	-	-	-	•	-	•	•	-	-	-	-	-	-	-	-	-	-	•	•
Temperature Sensors																				
Thermistor Probes and Assemblies	-	-	-	-	-	•	-	-	-	-	-	-	-	-	-	•	-	-	-	•
Surface Mount Thermistor	-	-	-	-	•	•	•	•	-	•	-	-	-	-	-	-	-	-	•	•
Glass-Encapsulated Thermistor	-	-	-	-	•	•	•	•	-	•	-	-	-	-	-	-	-	-	•	•

How Are the High Power TVS Diodes Used Here?

AK10 Series TVS Diodes

AK10 series TVS Diodes are designed on power distribution boards, power input, and GPU input to protect against any surge damage risk in outdoor servers. They have outdoor specifications up to 20 kV.

Specially designed to handle the severe surge test environments of both AC and DC line protection applications, they boast very fast response and ultra-low clamping characteristics compared with traditional Metal Oxide solutions. They can be connected in series or parallel or both to create a very high surge current protection solution.



Sensing

Product and Application Matrix

Littelfuse Product Series	Computer and Networking Equipment						Uninterruptible Power Supply			Communication Equipment				Power Distribution and Controls						
	USB	Ethernet	RS-232/RS-485	eSATA/SATA	Power Supply	Fans	AC Power Supply	Converter and Inverter	Battery Bank	Modem	ADSL Splitters, Channel/Data Service Unit	Repeaters, Mux, WAN	VoIP, LAN	Switchgear Panel	Automatic Transfer Switch	Power Distribution Unit	Busway	Panelboard	Backup Generator	HVAC
Magnetic Sensors and Reed Switches																				
Reed Sensors	-	-	-	-	•	-	•	-	-	-	-	-	-	•	•	•	-	•	-	-
Reed Switches	-	-	-	-	•	-	•	-	-	-	-	-	-	•	•	•	-	•	-	-
Temperature Sensors																				
Thermistor Probes and Assemblies	-	-	-	-	-	•	-	-	-	-	-	-	-	-	-	•	-	-	-	•
Surface Mount Thermistor	-	-	-	-	•	•	•	•	•	-	•	-	-	-	-	-	-	-	•	•
Glass-Encapsulated Thermistor	-	-	-	-	•	•	•	•	•	-	•	-	-	-	-	-	-	-	•	•

How Are the High Performance Fast Recovery Diodes and Ultra-Junction MOSFETs Used Here?

15 kVA HVDC Power Supply for Data Centers

The power supply is designed to convert 380 Vac to 10–290 Vdc. DSEP29-12A + IXFH60N65X2 is used as a part of Vienna rectifier-based, three-phase power factor correction.

IXFH80N65X2 is used as a switching of three-level LLC resonant converter and DSEI120-06A is used for output rectification.

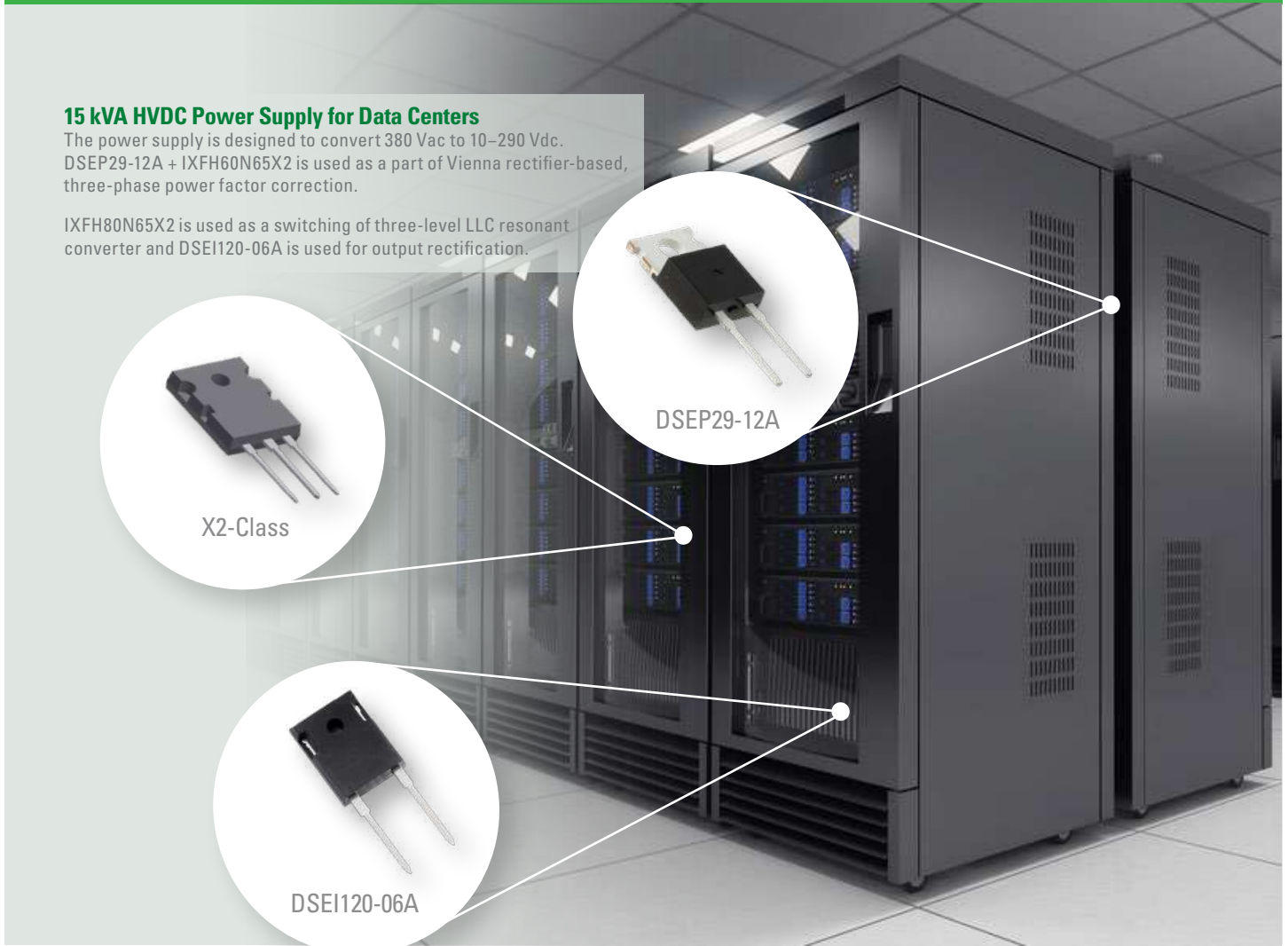
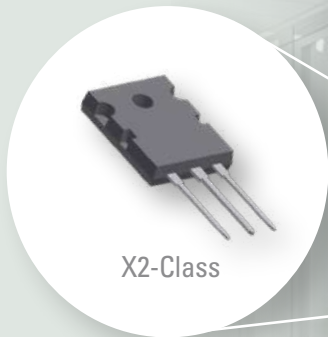

A Power Distribution and Controls

Protection and Control Products



	Technology	Series
1	UL Class Fuse	CCMR, JLLN, JLLS, KLDR, FLNR
	Fuseholder	LF, LFJ, LFT
2	Power Distribution Box	LD
3	Arc Flash Relay	AF0100, PGR-8800
4	Time Delay Relay	TMV, TRU
5	Voltage Monitoring Relay	455, 460
6	Surge Protection Device	SPD2
7	Ground Fault Relay and NGR Monitor	SE-704, SE-701, SE-330
8	Temperature Control	TCR9C
9	Alternating Relay	ALT
10	Load Sensor	LSRX, LSRX-C
11*	Capacitor	HCK
	Transformer	HCT
	Contactor	HCD
	Circuit Breaker	HCB
	Mechanical Relay	HCR

* Hartland Control products intended for environmental control (HVAC) applications.

How Is the Fast-Acting Fuse Used Here?

Very Fast Acting Sub-Miniature Fuses

456/463/458 Nano²® Series is used for high-end servers voltage regulator module and cooling fan systems and other high-current applications, such as storage devices.



B Computing Equipment Solutions

Power Supply (12 V/48 V)

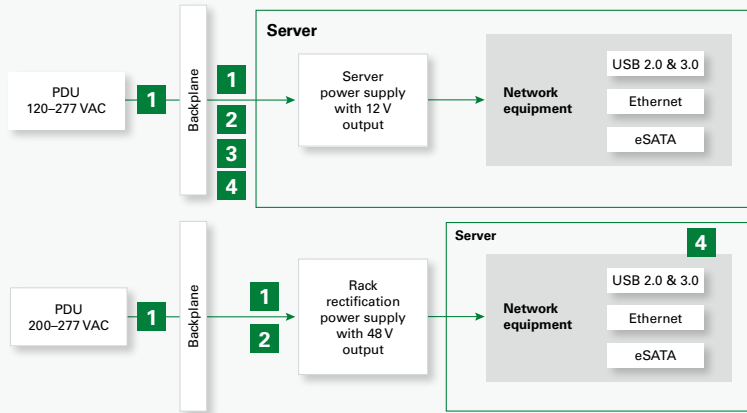

	Technology	Series
1	Fuse	881F, TLS, 456SD, 456SDE
2	Varistor	UltraMOV®
3	TVS Diode	SMDJ
4	Reed Sensor	59150, 59020

C Networking and Data Port Solutions

Lightning, ESD, and Power Fault Protection: PoE++

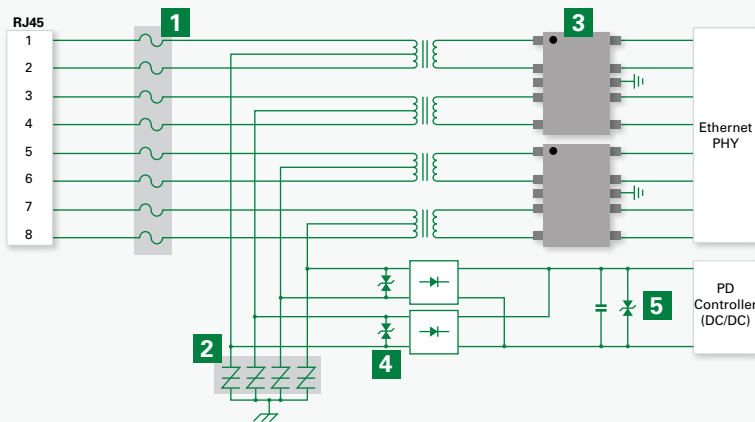

	Technology	Series
1	Fuse (x8)	461xxx
2	SIDACTor® (x4)	P4500SCLRP
3	Diode Array (x2)	SP2555NUTG, SP2525NUTG, SP3025-04HTG
4	TVS Diode (x2)	SMCJ58CA
5	TVS Diode (x1)	SMCJ58CA

Circuit Protection Solutions for Ethernet Port

Intra-Building

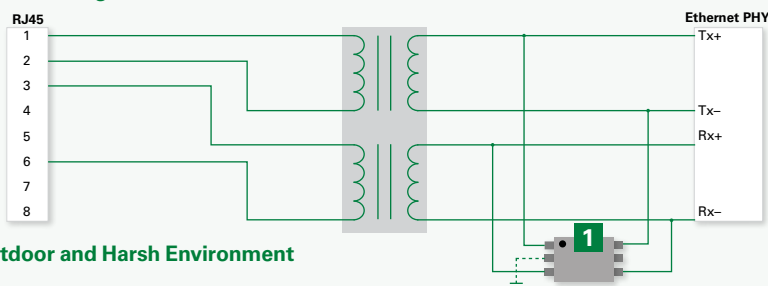

Outdoor and Harsh Environment

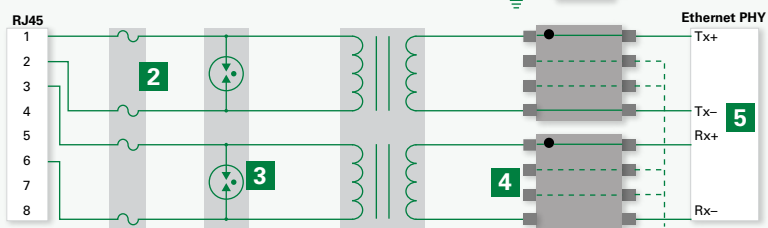

	Technology	Series
1	TVS Diode Array	SRV05-04HTG-D
2	Fuse	0461xxx
3	GDT	SG, CG6, CG5
4	TVS Diode Array	LC03xx, SP40xx
5	Switch	ITS, KT, K5V

C Networking and Data Port Solutions (Continued)

Circuit Protection Solutions for USB Type A and Type B

USB 2.0 (480 Mbps)

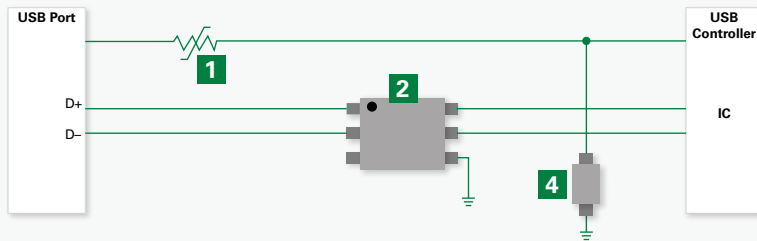

USB 3.2 Gen 1x1 (5 Gbps)

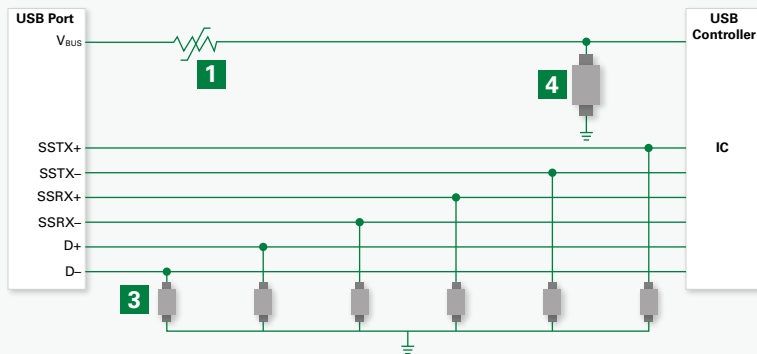

	Technology	Series
1	PPTC	Low Rho
2	TVS Diode Array	SP3019-04HTG; SP3400-02UTG
3	TVS Diode Array (x6)	SP3213-01UTG
4	TVS Diode Array	SP1006-01UTG

Circuit Protection Solutions for USB Type C

USB 3.2 Gen 2x1 (10 Gbps), USB 3.2 Gen 2x2 (20 Gbps), and USB 4.0 (40 Gbps)

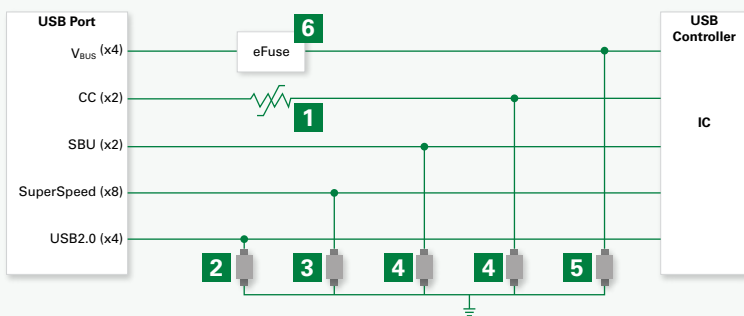

	Technology	Series
1	Digital Temperature Indicator	setP™
2	TVS Diode Array	SP3530-01UTG
3	TVS Diode Array	SP3213-01UTG
4	TVS Diode Array	SP1006-UTG
5	TVS Diode Array	SPHV24-01ETG
6	Protection IC (eFuse)	LS2406ERQ23

Circuit Protection Solutions for eSATA Port

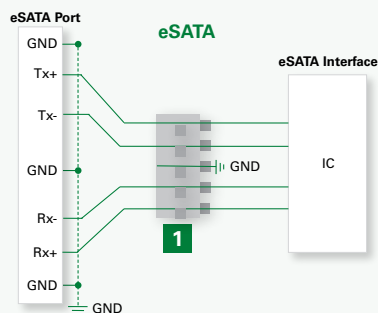

	Technology	Series
1	TVS Diode Array	SP1004U-ULC-04UTG

D Uninterruptible Power Supply (UPS) ¹

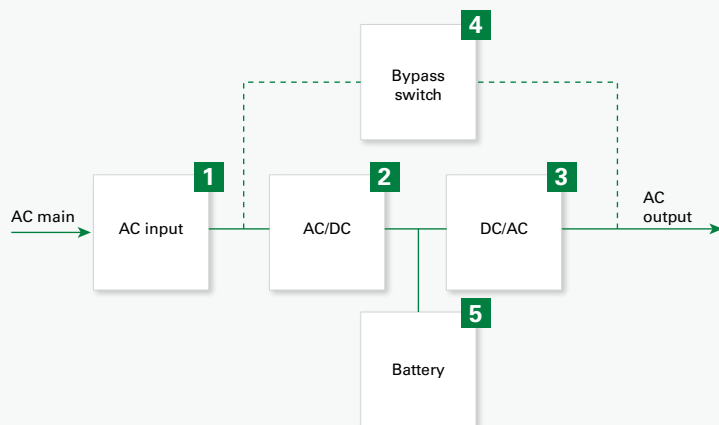

	Technology	Series
1	Fuse ² MOV ³ SIDACTor® and MOV Phase Control Thyristor	PSR, JLLS, 505, 607 TMOV, Xtreme Pxxx0FNL and LA PCT
	Rectifier Module ⁴ IGBT and MOSFET Gate Driver ⁵ Temp Sensor High Voltage MOSFET PPTC	MDD, VUO, MDMA XPT and Ultra-Junction X-Class IXD_6xx USP10976 IXTH6N150 250S130, RXEF160
3	IGBT Module Gate Driver ⁵ Temp Sensor	MIXA, MIXG IXD_6xx USP10976
4	Thyristor Module	MCC, MCMA
5	Switch	EITS, KT, K5V

Notes:

1. A double conversion online UPS diagram is used as a representative model. Other topologies will have similar solution needs at common power levels.
2. Many other fuse options are available, based on system attributes such as current, voltage, available fault current, surge withstand, and sensitivity of semiconductors.
3. For faster response, consider P6KE or a combination of a SIDACTor® and an MOV (P3500SCLRP and LA series).
4. Rectifier diodes can potentially be substituted with active rectification through IGBT for improved functionality.
5. Gate Drivers may require an isolator. Contact Littelfuse for recommendations.

D Power Supply Unit and Battery Backup

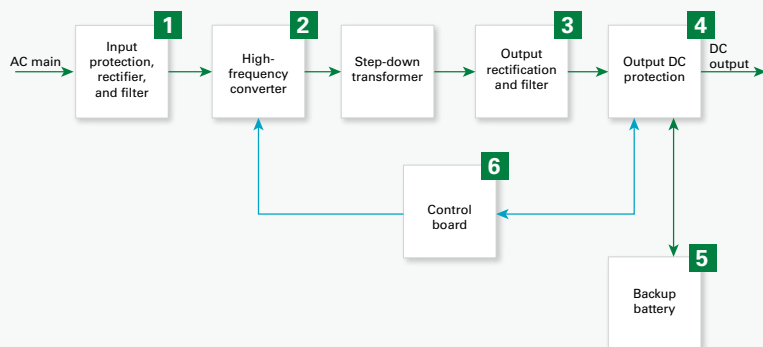

	Technology	Series
1	Fuse MOV GDT TVS Diode Magnetic Sensor	JLLN, PSR, 607 TMOV34S, Xtreme CG3 LTKAK10 MDCG
	TVS Diode MOSFET	P6KE, 1.5SMB, SMF4L X2-class
3	Schottky Diode	MBR, DST
4	Fuse	463, 881, TLS, PSR, 456SD, 456SDE
5	Fuse Temp Sensor TVS Diode Array PPTC Battery Protector Battery Mini-Breaker Switch	463, 881, TLS, PSR, 456SD, 456SDE RB AQ05C zeptoSMD ITV MHP-TAM EITS, KT, K5V
	Switch	EITS, KT, PTS, K5V

Disclaimer: Littelfuse products are not designed for, and should not be used for, any purpose (including, without limitation, automotive, military, aerospace, medical, life-saving, life-sustaining, or nuclear facility applications, devices intended for surgical implant into the body, or any other application in which the failure or lack of desired operation of the product may result in personal injury, death, or property damage) other than those expressly set forth in applicable Littelfuse product documentation. Warranties granted by Littelfuse shall be deemed void for products used for any purpose not expressly set forth in applicable Littelfuse documentation. Littelfuse shall not be liable for any claims or damages arising out of products used in applications not expressly intended by Littelfuse as set forth in applicable Littelfuse documentation. The sale and use of Littelfuse products is subject to Littelfuse Terms and Conditions of sale, unless otherwise agreed upon by Littelfuse. Information furnished is believed to be accurate and reliable. However, users should independently evaluate the suitability of and test each product selected for their own applications. Littelfuse products are not designed for—and must not be used in—all applications. Read the complete Disclaimer Notice at Littelfuse.com/disclaimer-electronics.

Highlighted Products



Surge Protection Devices



Circuit Breakers



Tactile Switches



Pushbutton Switches

TVS Diode Arrays



Toggle Switches



High-Speed Fuses



Industrial and UL-Class Fuses



Protection ICs (eFuses)



Fuses

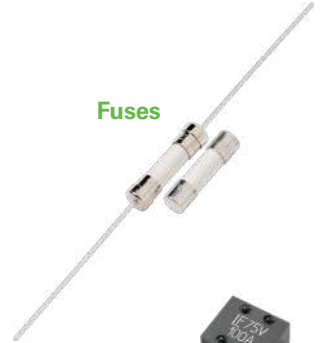

Gate Drivers

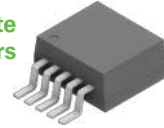

SMD Fuses



TVS Diodes

SMD Fuses



Multi-Oxide Varistors



Solid State Relays

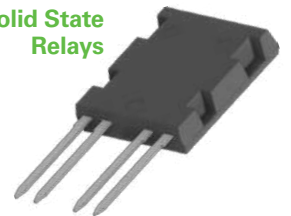

SCR Thyristors

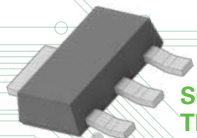

Discrete MOSFETs

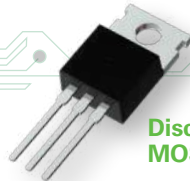

Reed Switches



PPTCs



TRIACs



3-Pole Contactors



Protection Relays



Additional Resources



Scan or click
to download

Circuit Protection Products Selection Guide

This guide provides a summary of key circuit protection factors to consider, descriptions of the technologies Littelfuse offers, and product selection tables. It is designed to help you quickly find a protection solution appropriate for your application.



Scan or click
to download

Telecom and Data Centers Application Note

C&K high-performance electromechanical solutions are durable, reliable, customizable, and cost-effective. C&K has a legacy of success in the telecom and data center industry, with a broad product portfolio that meets any design needs, including standard and miniature. This guide provides an overview of C&K Switches used in telecom and data center.



Scan or click
to download

Power Semiconductor and IC Selection Guide

This selection guide offers a comprehensive portfolio of power semiconductor and integrated circuit technologies in industry standard and innovative packages.



Scan or click
to download

Protection Relays and Controls Catalog

This catalog includes a comprehensive line of motor and pump protection relays, arc-flash relays, ground-fault relays, upstream protection, pump controllers, time delay relays, flashers and tower lighting, and more to minimize electrical safety hazards, limit equipment damage, improve productivity, and safeguard personnel from injury due to electrical faults.



Scan or click
to download

General Port Protection Solution

Protect your ports—featuring the latest innovative solutions from Littelfuse. Learn how these solutions address the following industries: automotive, building automation, consumer electronics, data center and cloud, industrial, mobile and wearables, etc.

Visit Technical Resources at Littelfuse.com

Technical information is only a click away. The Littelfuse Technical Resources page contains datasheets, product manuals, white papers, application guides, demos, online design tools, and more.

An Extension of Your Team

Littelfuse engineers are a phone call away to help identify potential issues and provide product recommendations to solve problems.

For general inquiries and information:

Littelfuse, Inc.
8755 West Higgins Road, Suite 500
Chicago, IL, 60631, USA
+1 773 628 1000
Littelfuse.com

For product purchase and support: [Littelfuse.com/ContactUs](https://www.littelfuse.com/ContactUs)

For lab services: [Littelfuse.com/Services](https://www.littelfuse.com/Services)

For product information: [Littelfuse.com/Products](https://www.littelfuse.com/Products)

Application and Field Support

Our experienced product and application engineers work closely with our customers from design to installation to find the best solution. Contact us today:

[Littelfuse.com/ContactUs.aspx](https://www.littelfuse.com/ContactUs.aspx)

©2024 Littelfuse, Inc. The information furnished here is believed to be accurate and reliable. However, users should independently evaluate the suitability of and test each product selected for their own applications. Littelfuse products are not designed for, and must not be used in, all applications. Read the complete Disclaimer Notice at [Littelfuse.com/Disclaimer-Electronics](https://www.littelfuse.com/Disclaimer-Electronics).

PolySwitch®, PulseGuard®, and SIDACTor® are registered trademarks of Littelfuse, Inc.

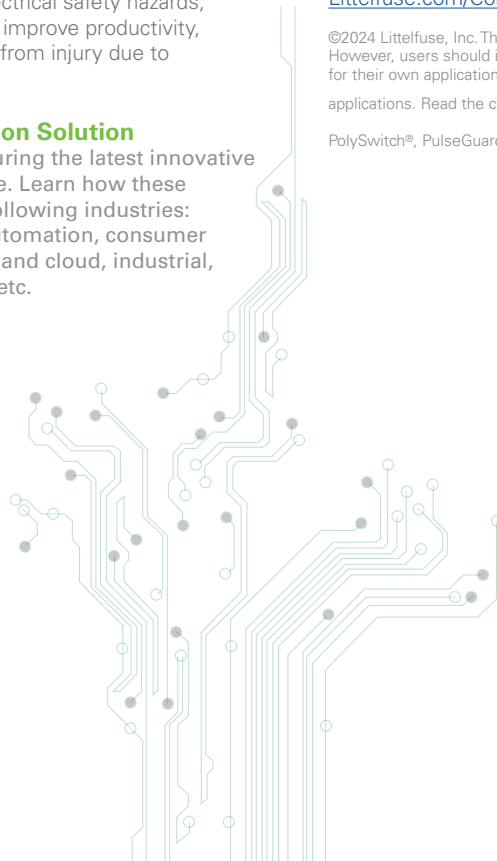

Global Lab Capabilities



You need to be certain that your products live up to the highest standards for performance, reliability, safety, and regulatory compliance. Working with Littelfuse, you have access to dedicated application engineers who partner with you to provide expert design consultation, perform comprehensive tests simulating the harshest environments, and confidentially evaluate the results with you.

TESTING CAPABILITIES

Environmental

- Autoclave
- Dust
- H3TRB
- HAST
- High and Low Temperature Storage
- High Temperature Loading
- Ingress Protection (IP)
- HTGB
- HTRB
- Temperature and Humidity
- Temperature Cycling
- Thermal Shock
- Salt Fog

Physical-Mechanical Characteristics

- Acceleration
- Die Shear
- Leak Detection
- Mechanical Shock
- Resistance to Soldering Heat (Dip, Reflow, Wave)
- Resistance to Solvents
- Solderability
- Terminal Strength (Push, Pull, Bend)
- Vibration
- Wetting Balance
- Wire Pull

Electrical

- BCI
- Capacitance
- EFT
- ESD
- Impedance
- Insulation Resistance
- I-V
- Life
- Lightning Surge
- Overload
- Parametric Tests
- Power-Cross
- Power Cycling
- Ring Wave
- R-T
- S-Parameter Measurements (Insertion Loss, Isolation, Reflection)
- Short Circuit
- Step Current
- Surface Resistivity
- Surge
- TDR (Eye Diagram)
- Telecom
- Thermal Cut-Off
- Time-to-Trip
- TLP
- Transient
- Trip Cycle
- Trip Endurance
- Voltage Drop



To access this guide and other Littelfuse literature in an interactive and mobile-friendly format, please visit our eCatalog library.

Scan to visit



LOCAL RESOURCES FOR A GLOBAL MARKET

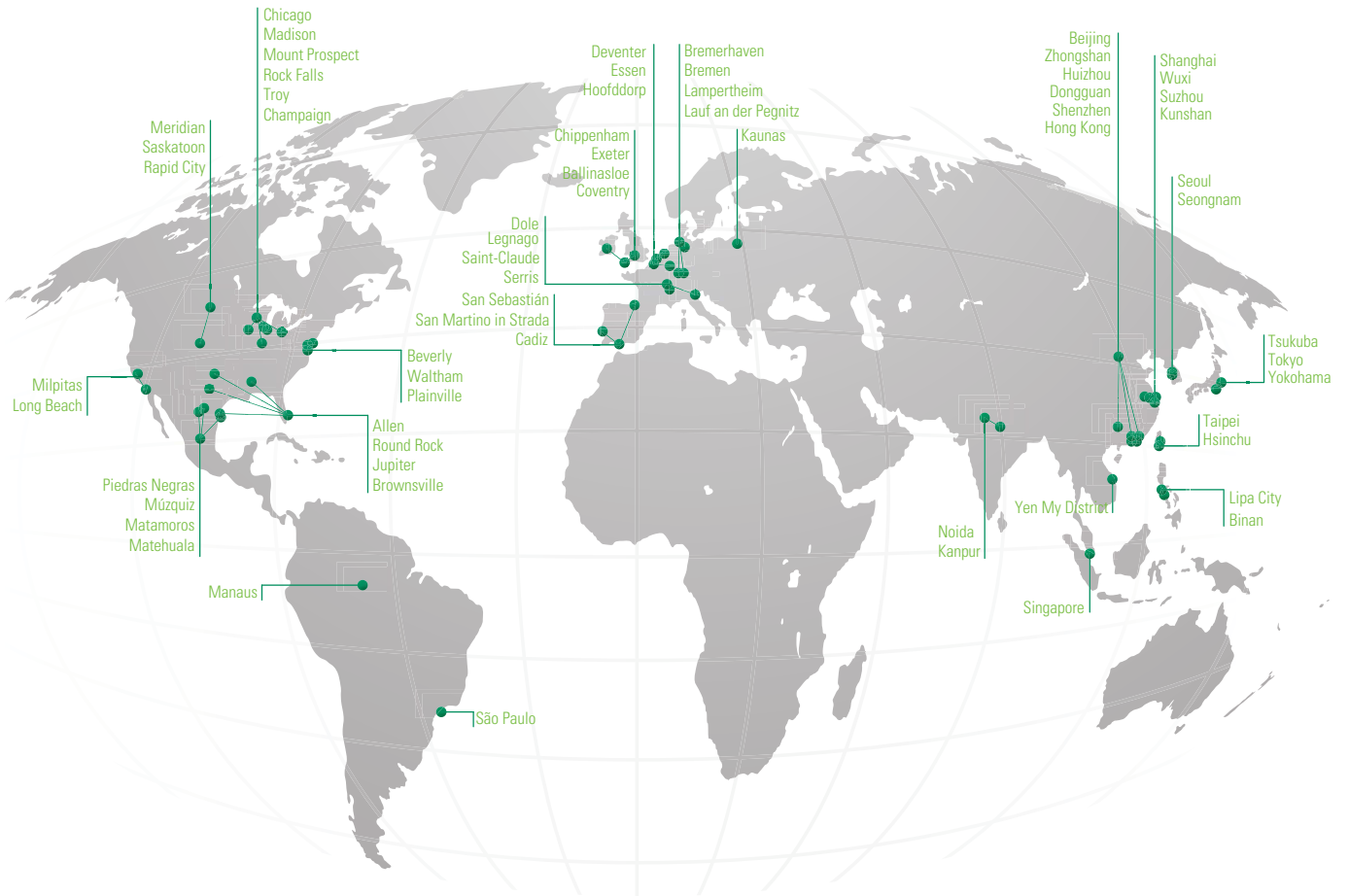

Littelfuse products are certified to many standards around the world. To check certifications on specific products, please refer to the product datasheet on [Littelfuse.com](https://www.littelfuse.com).



Expertise Applied | Answers Delivered